



## E-KABİN D SERİSİ

IP41 Elektrik Kabinleri





## E-Kabin D Serisi Elektrik Kabinleri

E-Kabin D Serisi elektrik kabinleri genel amaçlı olarak, dahili uygulamalarda kullanılmak üzere tasarlanmıştır. Sade tasarımları farklı uygulamalar için işlevsellik ile beraber ekonomik çözümler sunmaktadır.

Kullanım yeri	: Dahili, kuru ortam
Koruma sınıfı	: IP41
Taşıyıcı konstrüksiyon	: 2mm galvanizli sac
Boya	: epoksi - polyester toz boya
Renk	: Standart RAL 7035
İşletme sıcaklığı	: -5°C , +40°C
İşletme bağıl nem oranı	: +20°C' de %90 +40°C' de %50
Uygun olduğu standartlar	: IEC 61439-1 IEC 62208 IEC 60529 IEC 62262

# ÖZELLİKLER

## Estetik görünüm

Eloksallı alüminyum profilden imal edilen üst eşik estetik bir görünüm sağlamaktadır.



## Sağlam kilit düzeneği

Kilitleme düzeneği kapının gövdeye dört farklı noktadan tutunmasını sağlar.

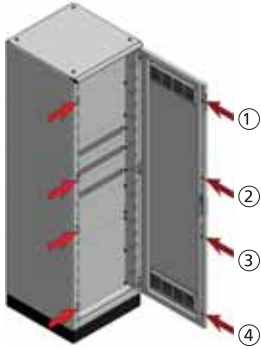

## Kullanışlı kilit yapısı

Kapının açılması kilit kolunun kaldırılması ve çevrilmesi suretiyle sağlanır. Anahtar ile kilitlemesi kullanıcı tarafından belirlenir. İstenmediğinde kilitlemede kullanılabilir.



## IP41 koruma sınıfı

Kapı üzerine yerinde dökülen poliüretan conta zamanla esnekliğini kaybetmez, toz ve suya karşı koruma sağlar.



## Kolay montaj

Kuvvetli iskelet ve iç montaj elemanları sayesinde kapı ve kapakların sabitlenmesi elektromontaj sonrasında gerçekleşmektedir.



## Geniş ön kapı seçenekleri

- Sağlam cam tutucular
- Kullanışlı havalandırma panjuru
- Siparişe özel işlenmiş kapı imalatı
- Polikarbonat veya temperli cam
- Simetrik kapı

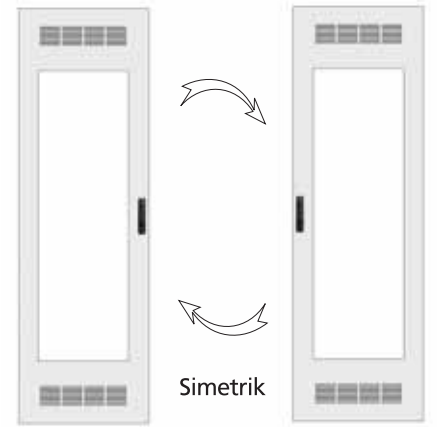

- Kullanışlı aksesuarlar
- Kapı profili seti
- Diz üstü bilgisayar masası

## Modüler tasarım

Arkada ve önde kapı kullanımı  
Değiştirilebilir kapı açılma yönü  
Köşe modülü



# İÇ MONTAJ ELEMANLARI

## MA Montaj Profili

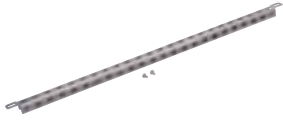

### Ürün Kapsamı

- MA Montaj Profili
- M5x8mm Kılavuz Civata - 2 ad.

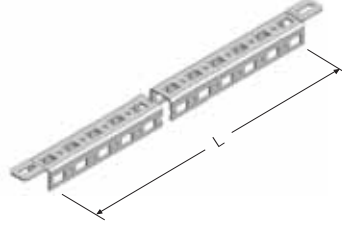
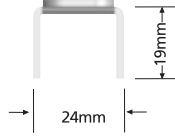

## MB Montaj Profili

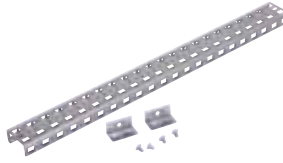

### Ürün Kapsamı

- MB Montaj Profili
- MBT Tespit Takımı - 2 ad.

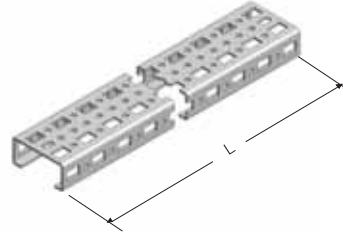
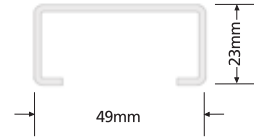

## MC Montaj Profili



### Ürün Kapsamı

- MC Montaj Profili
- M5x8mm Kılavuz Civata - 2 ad.

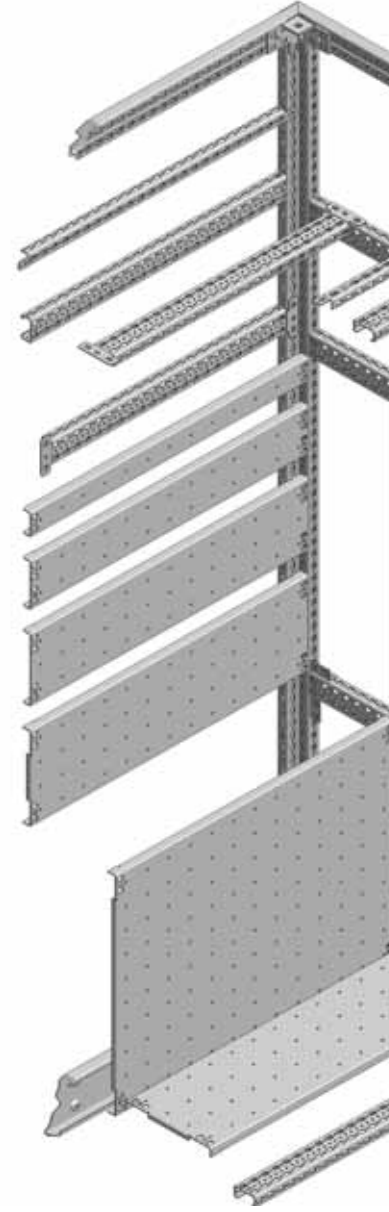
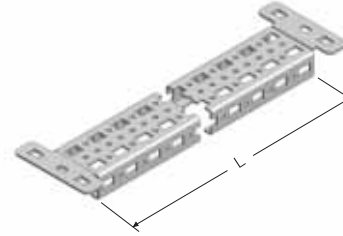
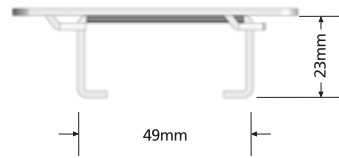

### Ürün Kodlama Bilgileri

Örnek; 75 cm uzunluğunda MA tipi montaj profili

Ürün Kodu : EG MA 072

Ürün Serisi : EG

Profil tipi : MA, MB, MC

Uzunluk Kodlamaları : 0 7 2

İlk iki hane x 10cm

Son hane x 2,5cm

Örnek Profil Uzunluğu  
L = 75cm : MB 072  
L = 70cm : MB 070

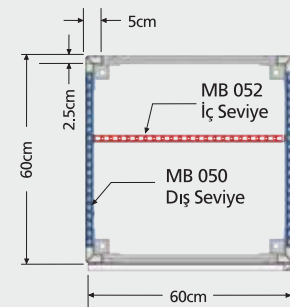

## MP Montaj Plakaları

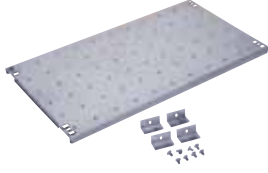

### Ürün Kapsamı

- MP Montaj Profili
- MBT Tespit Takımı - 2 ad.

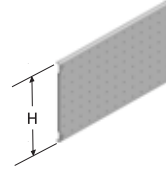

Sipariş kodları ve ölçüler için bkz. Sayfa 12 - 13

## MK Boy Montaj Plakaları



### Ürün Kapsamı

- MK Boy Montaj Plakası
- MK Tespit Profili - 2 ad.
- BMT Sabitleme Takımı

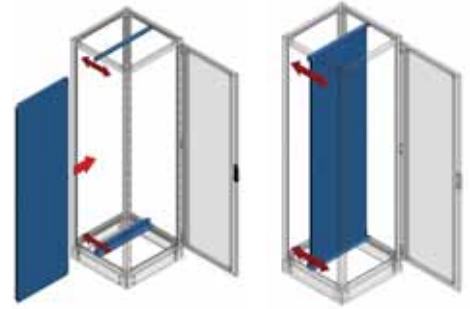

Sipariş kodları ve ölçüler için bkz. Sayfa 12 - 13

## MO Boy Montaj Plakaları

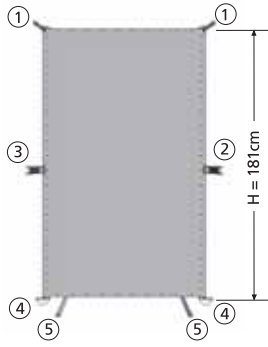

### Ürün Kapsamı

- MO Boy Montaj Plakası
- MO Tespit Takımı bkz. ① ② ③ ④ ⑤

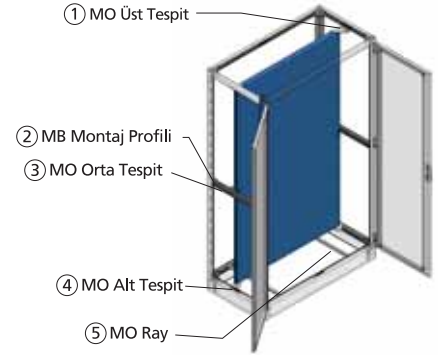

Sipariş kodları ve ölçüler için bkz. Sayfa 12 - 13

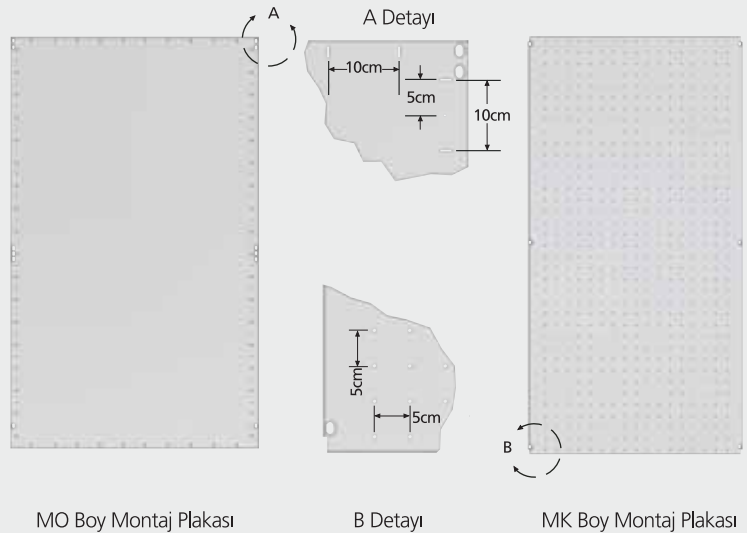
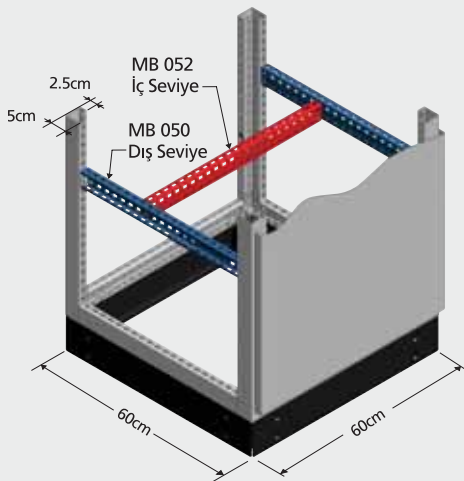

MO Boy Montaj Plakası

B Detayı

MK Boy Montaj Plakası

# ÖZEL MONTAJ ELEMANLARI

## RM Özel Montaj Profili

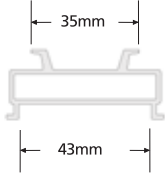
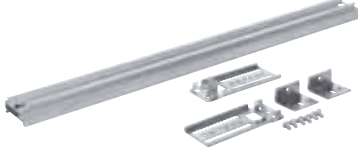

Alüminyum

### Ürün Kapsamı

- RM Montaj Profili
- DST 100 Tespit Takımı

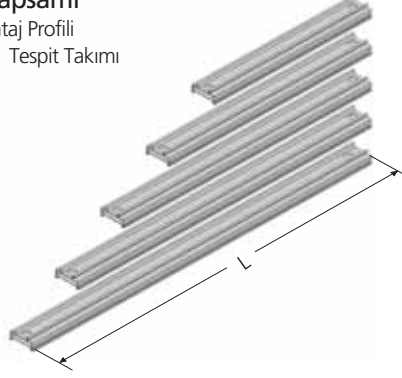

- EG RM 04 (346mm)
- EG RM 05 (446mm)
- EG RM 06 (546mm)
- EG RM 07 (646mm)
- EG RM 08 (746mm)

Anma kabin genişlik kodları  
- iç seviye ölçüsü -



## SP Özel Montaj Profili

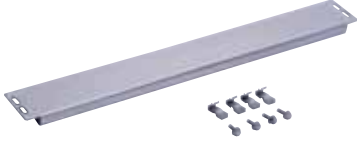

### Ürün Kapsamı

- SP Montaj Profili
- SPT Bağlantı Takımı

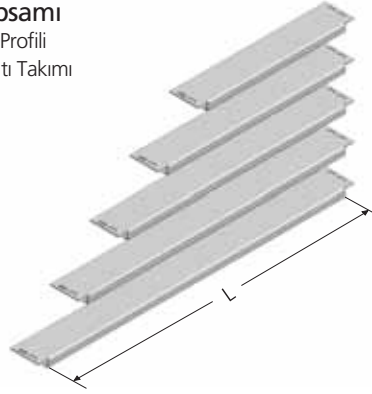

- EG SP 04 (346mm)
- EG SP 05 (446mm)
- EG SP 06 (546mm)
- EG SP 07 (646mm)
- EG SP 08 (746mm)

Anma kabin genişlik kodları  
- iç seviye ölçüsü -



### RM Profil Montaj Örneği

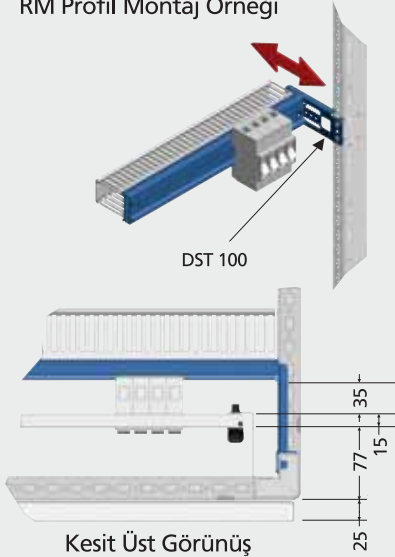

### RM Profil Montaj Örneği

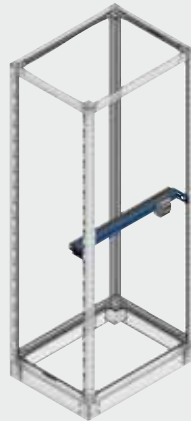

### SP Profil Montaj Örnekleri

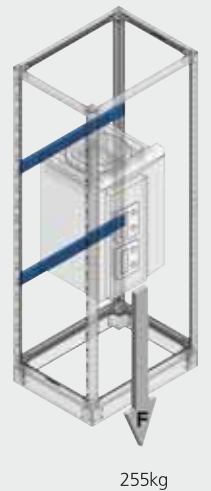
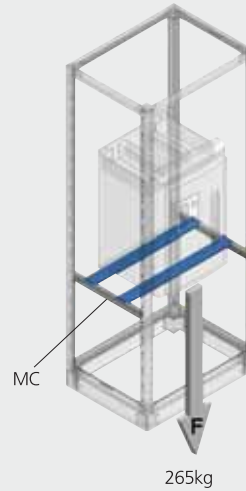



## SY Özel Montaj Profili

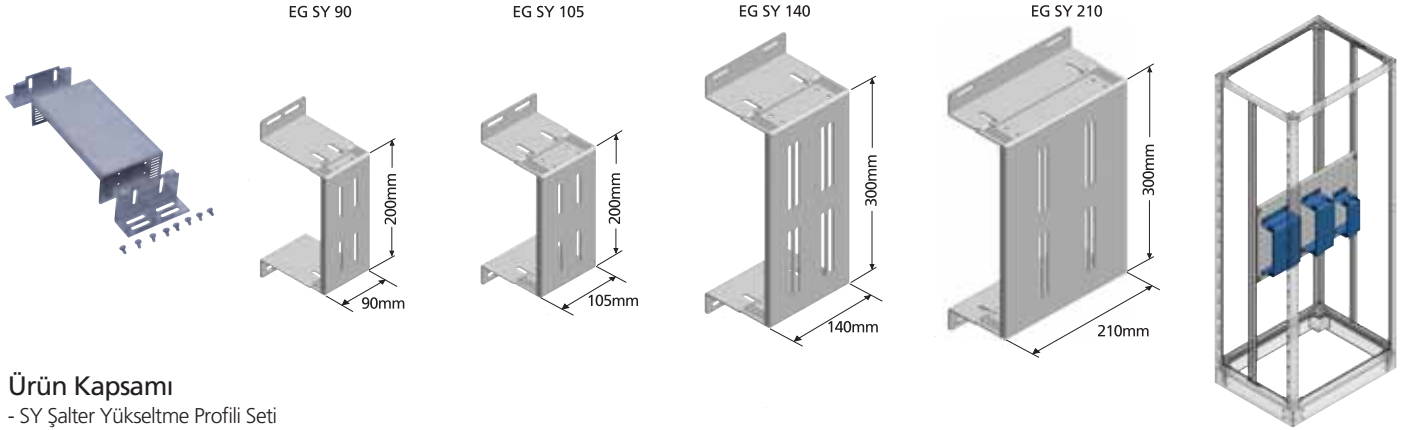

### Ürün Kapsamı

- SY Şalter Yükseltme Profili Seti
- SY Şalter Yükseltme YükseltmeTakımı

## DST Özel Montaj Tespit Takımı

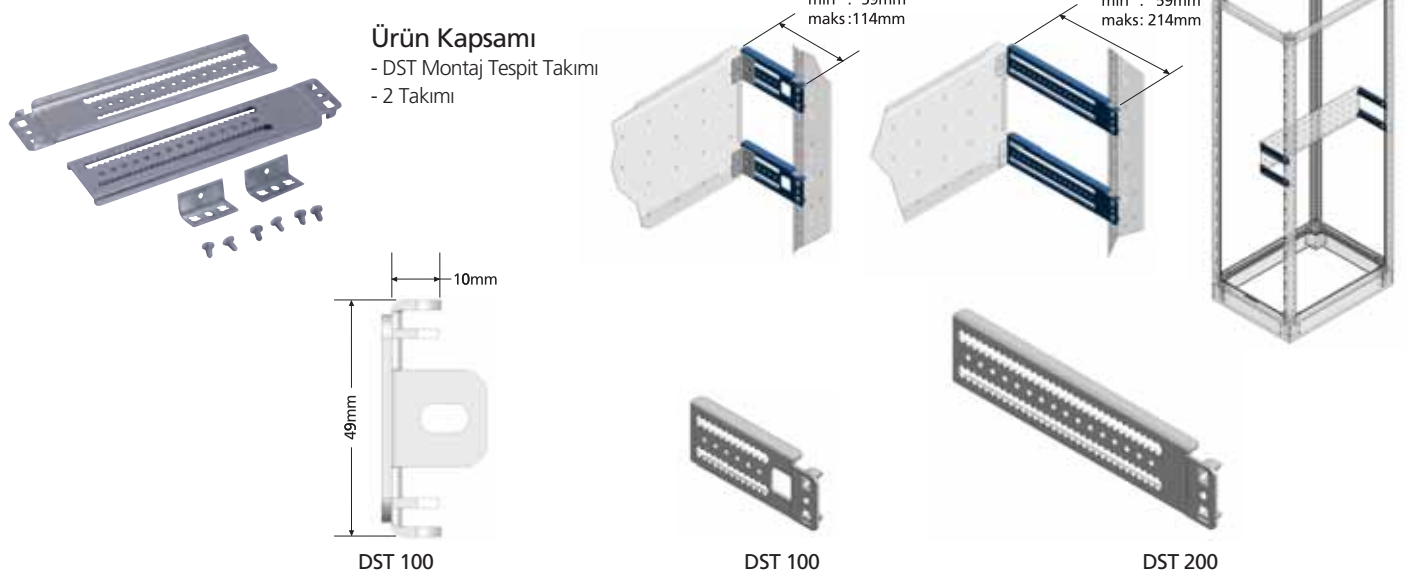

### Ürün Kapsamı

- DST Montaj Tespit Takımı
- 2 Takımı

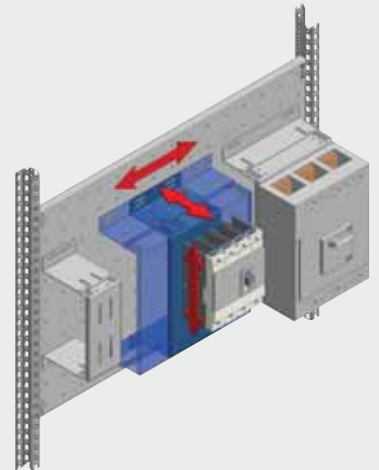
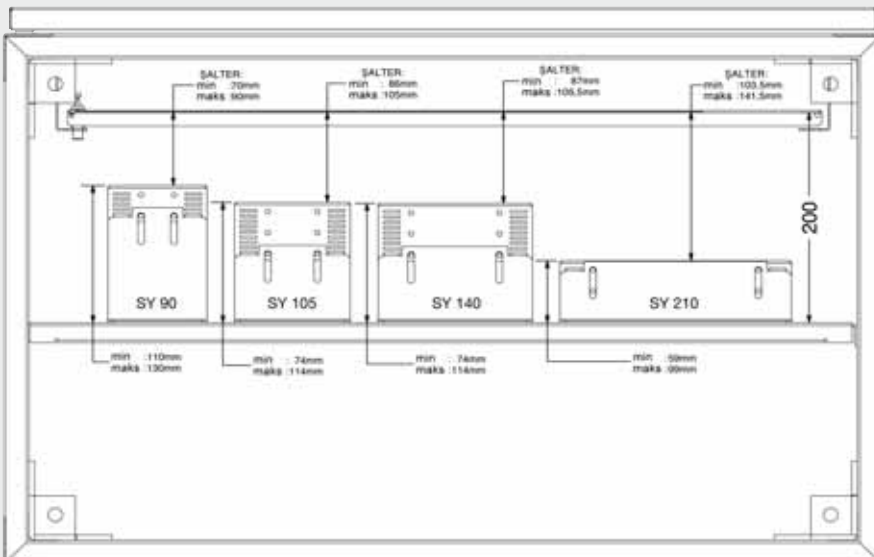

# ÖN ÖRTÜ ELEMANLARI

## OE Örtü Plakaları



### Ürün Kapsamı

- OE Örtü Plakası
- OET Bağlantı Takımı

15cm ve 20cm yüksekliğindeki ön örtü plakaları üzerinde DIN ray tipi ekipman için yarık uygulanabilir.

Bu durumda sipariş kodunun sonuna " A " harfi eklenir.

Örnek ; EG OE 1506 A

EG OE 2006 A



A  
Tipi

15cm ve 20cm yüksekliğindeki ön örtü plakaları üzerinde havalandırma yarıkları uygulanabilir.

Bu durumda sipariş kodunun sonuna " P " harfi eklenir.

Örnek ; EG OE 1506 P

### Ürün Kapsamı

- OE Örtü Plakası
- OET Bağlantı Takımı



P  
Tipi

Sipariş kodları ve ölçüler için bkz. Sayfa 12 - 13

## OB Boy Örtü Plakaları



### Ürün Kapsamı

- OB Örtü Plakası
- OBT Bağlantı Takımı



Sipariş kodları ve ölçüler için bkz. Sayfa 12 - 13

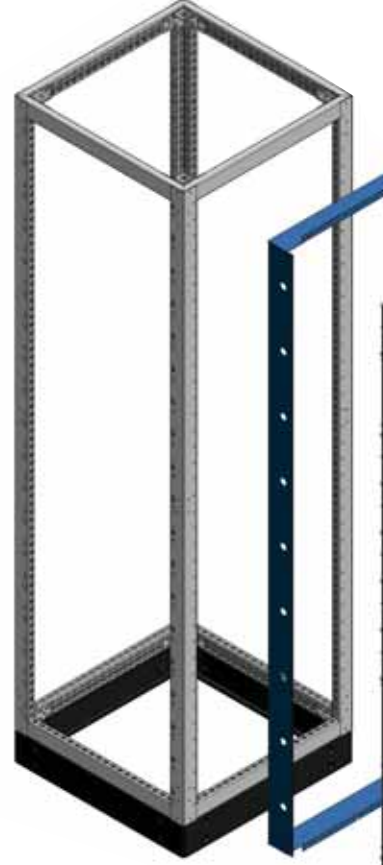

OE Pim düşmez



Açık



Çeyrek  
Çevrim



Kapalı



OET Bağlantı takımı

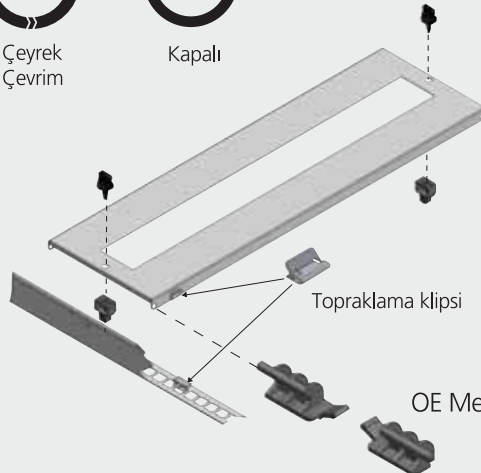

Topraklama klipsi

OE Mentşe

Boş kalan yerleri  
örtmek için aksesuar  
EE PP 2M

## OS Sabit Ön Örtü Profil Seti

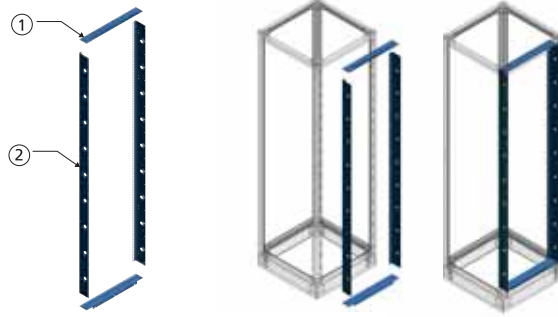

### Ürün Kapsamı

- ① - OS UP profili - 2 ad.
- ② - OS OP profili - 2 ad.
- Bağlantı elemanları - 1 set

Kapı ile Ön Örtü düzlemi arasındaki mesafe 10cm'dir.  
bkz. Sayfa 6 - Kesit Üst Görünüş

## OC Ön Örtü Profil Seti ve Çerçevesi

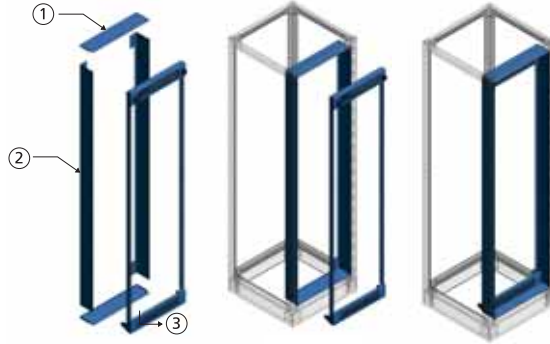

### Ürün Kapsamı

- ① - OC OU profili - 2 ad.
- ② - OC OP profili - 2 ad.
- ③ - OC Örtü Çerçevesi - 1 ad.
- Bağlantı elemanları - 1 set

Kapı ile Ön Örtü düzlemi arasındaki mesafe 10cm'dir.  
bkz. Sayfa 6 - Kesit Üst Görünüş

Sipariş kodları ve ölçüler için bkz. Sayfa 12 - 13

### Örnek seçim

#### OS 2006

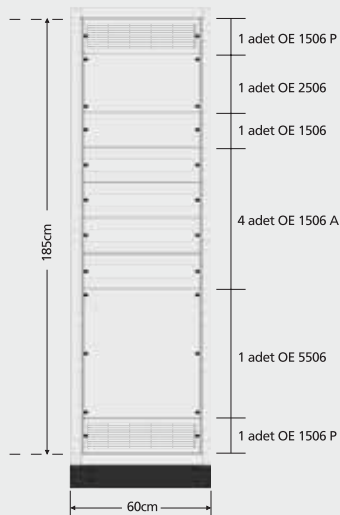
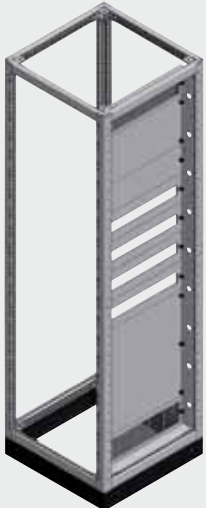

#### OC 2006

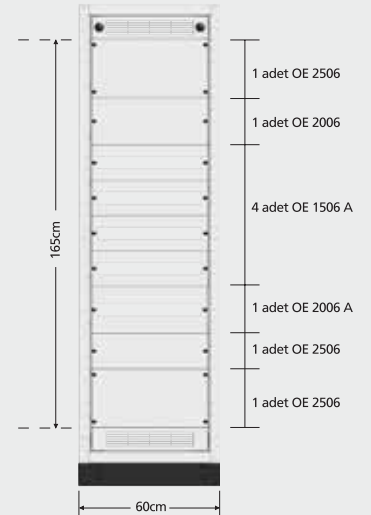
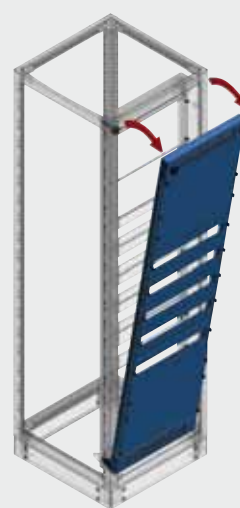

# SİPARİŞ BİLGİLERİ

## DP Dikey Profil Seti

180cm 200cm 220cm

ED DP 18 ED DP 20 ED DP 22

DP Seti Kapsamı

- Dikey profil - 4 adet.
- Köşe Birleştirme Takımı - 8 adet.
- M8x20mm imbus civata - 32 adet

## MS Modül Seti

Genişlik	Derinlik				
	40cm	50cm	60cm	70cm	80cm
40cm	ED MS 0404	ED MS 0405	ED MS 0406	ED MS 0407	ED MS 0408
50cm	ED MS 0504	ED MS 0505	ED MS 0506	ED MS 0507	ED MS 0508
60cm	ED MS 0604	ED MS 0605	ED MS 0606	ED MS 0607	ED MS 0608
70cm	ED MS 0704	ED MS 0705	ED MS 0706	ED MS 0707	ED MS 0708
80cm	ED MS 0804	ED MS 0805	ED MS 0806	ED MS 0807	ED MS 0808
90cm	ED MS 0904	ED MS 0905	ED MS 0906	ED MS 0907	ED MS 0908
100cm	ED MS 1004	ED MS 1005	ED MS 1006	ED MS 1007	ED MS 1008
110cm	ED MS 1104	ED MS 1105	ED MS 1106	ED MS 1107	ED MS 1108
120cm	ED MS 1204	ED MS 1205	ED MS 1206	ED MS 1207	ED MS 1208

MS Seti Kapsamı

- Yatay profil (genişlik ölçüsünde) - 4 adet.
- Yatay profil (derinlik ölçüsünde) - 4 adet.
- Üst Kapak Bağlantı Takımı - 1 adet
- Baza Seti - 1 adet
- Baza Bağlantı Takımı - 1 adet

Not: Üst kapakta fan modülünün montajına uygun delik bulunması istenen durumlarda ürün kodunun sonuna " FM " kodu eklenecektir. Örnek: ED MS 0606 FM

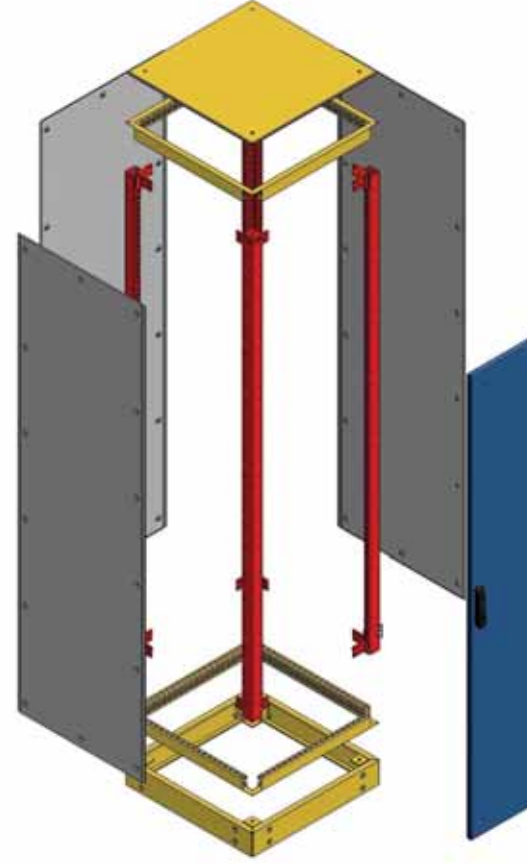

## UK Üst Kapak

Genişlik	Derinlik				
	40cm	50cm	60cm	70cm	80cm
40cm	ED UK 0404	ED UK 0405	ED UK 0406	ED UK 0407	ED UK 0408
50cm	ED UK 0504	ED UK 0505	ED UK 0506	ED UK 0507	ED UK 0508
60cm	ED UK 0604	ED UK 0605	ED UK 0606	ED UK 0607	ED UK 0608
70cm	ED UK 0704	ED UK 0705	ED UK 0706	ED UK 0707	ED UK 0708
80cm	ED UK 0804	ED UK 0805	ED UK 0806	ED UK 0807	ED UK 0808
100cm	ED UK 1004	ED UK 1005	ED UK 1006	ED UK 1007	ED UK 1008
120cm	ED UK 1204	ED UK 1205	ED UK 1206	ED UK 1207	ED UK 1208

Not: Fan modülü takılacak üst kapak tiplerinde ürün kodunun sonuna " FM " kodu eklenecektir. Örnek: ED MS 0606 FM

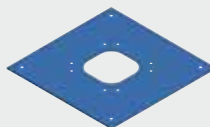

EG FM Fan Modülü Ürün Kapsamı

- ES FM Fan Modülü Sabitleme Takımı - 1 adet.
- ES FM Fan Modülü Üst Kapağı - 1 adet.
- Filtre Tavası - 1 adet
- Filtre - 1 adet

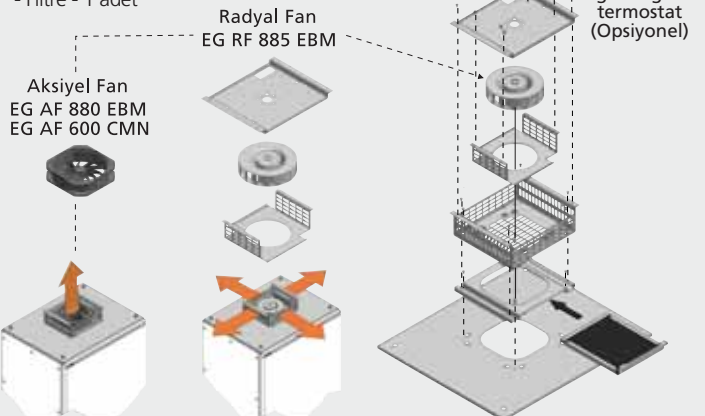

## OK Ön Kapı - D0 Tipi

Yükseklik	Genişlik						
	40cm	50cm	60cm	70cm	80cm	100cm	120cm
180cm	ED OK 1804 D0	ED OK 1805 D0	ED OK 1806 D0	ED OK 1807 D0	ED OK 1808 D0	ED OK 1855 D0	ED OK 1866 D0
200cm	ED OK 2004 D0	ED OK 2005 D0	ED OK 2006 D0	ED OK 2007 D0	ED OK 2008 D0	ED OK 2055 D0	ED OK 2066 D0
220cm	ED OK 2204 D0	ED OK 2205 D0	ED OK 2206 D0	ED OK 2207 D0	ED OK 2208 D0	ED OK 2255 D0	ED OK 2266 D0

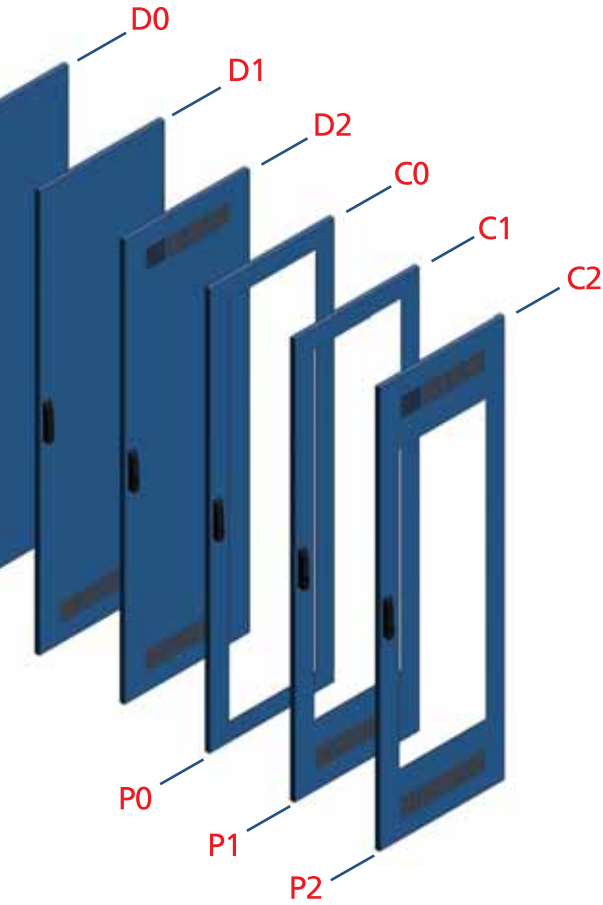

Not: Ön kapak kodlarının sonundaki D0 kodu D1-D2-C0-C1-C2-P0-P1-P2 şeklinde değiştirilerek tüm kodlar oluşturulur.

## SK Sabit Kapak

Yükseklik	Derinlik				
	40cm	50cm	60cm	70cm	80cm
180cm	ED SK 1804	ED SK 1805	ED SK 1806	ED SK 1807	ED SK 1808
200cm	ED SK 2004	ED SK 2005	ED SK 2006	ED SK 2007	ED SK 2008
220cm	ED SK 2204	ED SK 2205	ED SK 2206	ED SK 2207	ED SK 2208

Tablolarda kullanılan yükseklik, derinlik ve genişlik ölçüleri anma değerleridir. Gerçek değerler için bkz. Sayfa 14 - 15

## Baza Seti

Genişlik	Derinlik				
	40cm	50cm	60cm	70cm	80cm
40cm	EG BZ 0404	EG BZ 0405	EG BZ 0406	EG BZ 0407	EG BZ 0408
50cm	EG BZ 0504	EG BZ 0505	EG BZ 0506	EG BZ 0507	EG BZ 0508
60cm	EG BZ 0604	EG BZ 0605	EG BZ 0606	EG BZ 0607	EG BZ 0608
70cm	EG BZ 0704	EG BZ 0705	EG BZ 0706	EG BZ 0707	EG BZ 0708
80cm	EG BZ 0804	EG BZ 0805	EG BZ 0806	EG BZ 0807	EG BZ 0808
100cm	EG BZ 1004	EG BZ 1005	EG BZ 1006	EG BZ 1007	EG BZ 1008
120cm	EG BZ 1204	EG BZ 1205	EG BZ 1206	EG BZ 1207	EG BZ 1208

BZ Baza Seti Kapsamı  
Baza Köşe - 4 adet  
Baza Profili - 4 adet  
Bağlantı Civataları

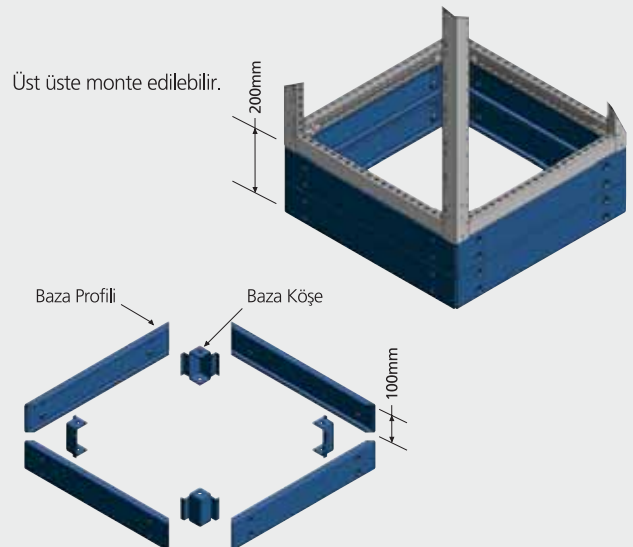

# SİPARİŞ KODLARI VE ÖLÇÜLER

## MP Montaj Plakaları Kodlar

h1 Anma Ölçü	Kabin anma genişliği				
	04	05	06	07	08
5cm	EG MP 0504	EG MP 0505	EG MP 0506	EG MP 0507	EG MP 0508
10cm	EG MP 1004	EG MP 1005	EG MP 1006	EG MP 1007	EG MP 1008
15cm	EG MP 1504	EG MP 1505	EG MP 1506	EG MP 1507	EG MP 1508
20cm	EG MP 2004	EG MP 2005	EG MP 2006	EG MP 2007	EG MP 2008
25cm	EG MP 2504	EG MP 2505	EG MP 2506	EG MP 2507	EG MP 2508
30cm	EG MP 3004	EG MP 3005	EG MP 3006	EG MP 3007	EG MP 3008
40cm	EG MP 4004	EG MP 4005	EG MP 4006	EG MP 4007	EG MP 4008
50cm	EG MP 5004	EG MP 5005	EG MP 5006	EG MP 5007	EG MP 5008
60cm	EG MP 6004	EG MP 6005	EG MP 6006	EG MP 6007	EG MP 6008

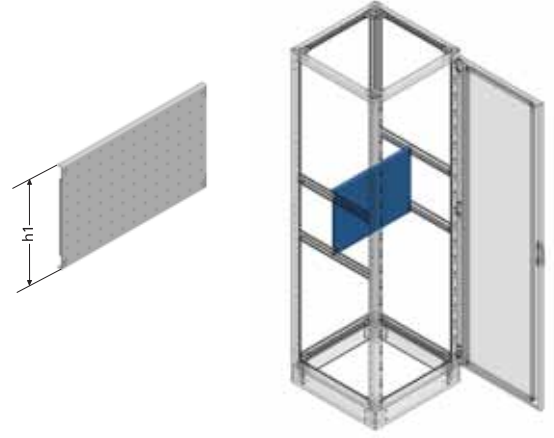

## MP Montaj Plakaları Ölçüler

Ölçü h1	Yükseklik								
	05	10	15	20	25	30	40	50	60
Net Ölçü	4.8cm	9.8cm	14.8cm	19.8cm	24.8cm	29.8cm	39.8cm	49.8cm	59.8cm



## MK Boy Montaj Plakaları Kodlar

Anma Yükseklik	Kabin anma genişliği							
	04	05	06	07	08	10	12	
180	EG MK 1804	EG MK 1805	EG MK 1806	EG MK 1807	EG MK 1808	EG MK 1855	EG MK 1866	
200	EG MK 2004	EG MK 2005	EG MK 2006	EG MK 2007	EG MK 2008	EG MK 2055	EG MK 2066	
220	EG MK 2204	EG MK 2205	EG MK 2206	EG MK 2207	EG MK 2208	EG MK 2255	EG MK 2266	

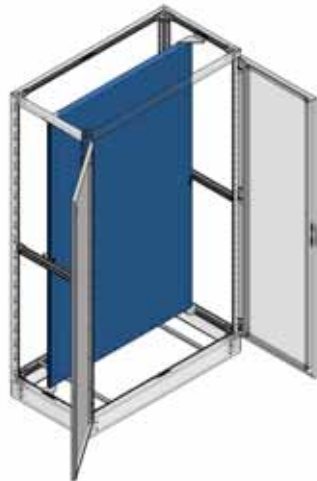

## MO Boy Montaj Plakaları Kodlar

Anma Derinlik	Kabin anma genişliği		
	08	10	12
05	EG MO 200805	EG MO 205505	EG MO 206605
06	EG MO 200806	EG MO 205506	EG MO 206606

# SİPARİŞ KODLARI VE ÖLÇÜLER

## OS Ön Örtü Profil Seti Kodlar

Anma	Kabin anma yüksekliği				
Yükseklik	04	05	06	07	08
18	EG OB 1804	EG OB 1805	EG OB 1806	EG OB 1807	EG OB 1808
20	EG OB 2004	EG OB 2005	EG OB 2006	EG OB 2007	EG OB 2008
22	EG OB 2204	EG OB 2205	EG OB 2206	EG OB 2207	EG OB 2008

## OC Ön Örtü Profil Seti ve Çerçevesi Kodlar

Anma	Kabin anma genişliği				
Yükseklik	04	05	06	07	08
18	EG OC 1804	EG OC 1805	EG OC 1806	EG OC 1807	EG OC 1808
20	EG OC 2004	EG OC 2005	EG OC 2006	EG OC 2007	EG OC 2008
22	EG OC 2204	EG OC 2205	EG OC 2206	EG OC 2207	EG OC 2008

## OC Ön Örtü Profil Seti ve Çerçevesi Ölçüler

Anma Ölçüsü h3	18	20	22
Net Ölçü	145cm	165cm	185cm

## OB Boy Örtü Plakaları Kodlar

Anma	Kabin anma genişliği				
Yükseklik	04	05	06	07	08
18	EG OB 1804	EG OB 1805	EG OB 1806	EG OB 1807	EG OB 1808
20	EG OB 2004	EG OB 2005	EG OB 2006	EG OB 2007	EG OB 2008
22	EG OB 2204	EG OB 2205	EG OB 2206	EG OB 2207	EG OB 2008

## OE Örtü Plakaları Kodlar

h4 Anma Ölçü	Kabin anma genişliği				
	04	05	06	07	08
5cm	EG OE 0504	EG OE 0505	EG OE 0506	EG OE 0507	EG OE 0508
10cm	EG OE 1004	EG OE 1005	EG OE 1006	EG OE 1007	EG OE 1008
15cm	EG OE 1504	EG OE 1505	EG OE 1506	EG OE 1507	EG OE 1508
20cm	EG OE 2004	EG OE 2005	EG OE 2006	EG OE 2007	EG OE 2008
25cm	EG OE 2504	EG OE 2505	EG OE 2506	EG OE 2507	EG OE 2508
30cm	EG OE 3004	EG OE 3005	EG OE 3006	EG OE 3007	EG OE 3008
40cm	EG OE 4004	EG OE 4005	EG OE 4006	EG OE 4007	EG OE 4008
55cm	EG OE 5504	EG OE 5505	EG OE 5506	EG OE 5507	EG OE 5508
60cm	EG OE 6004	EG OE 6005	EG OE 6006	EG OE 6007	EG OE 6008

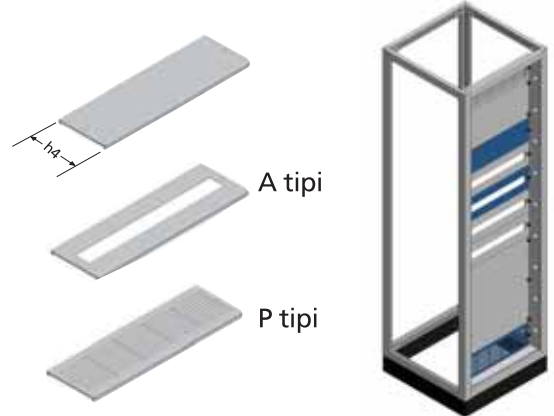
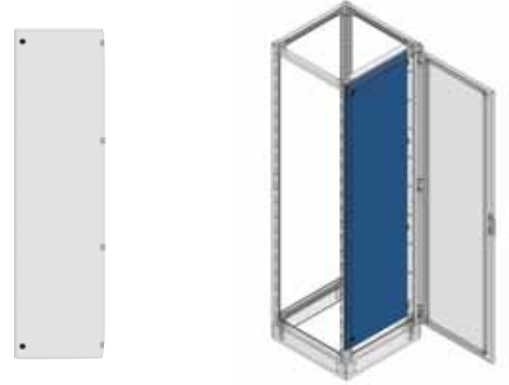
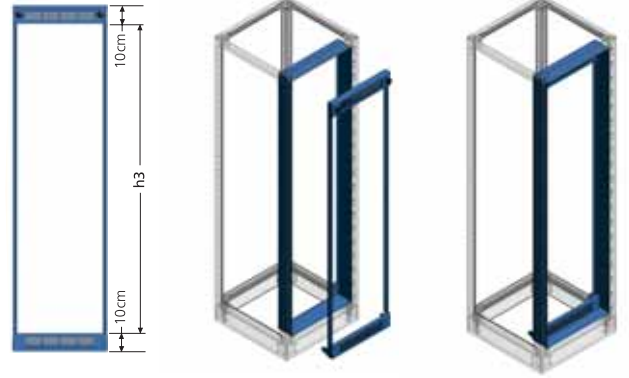
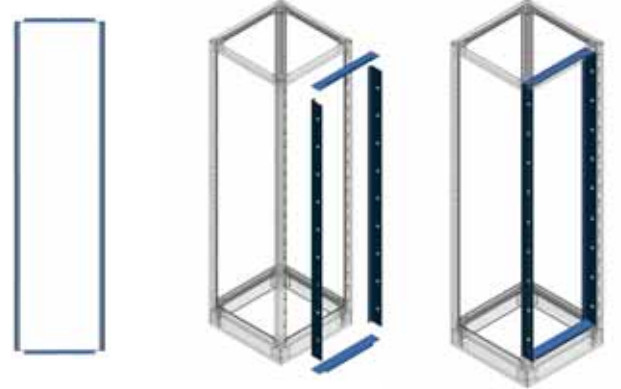

A ve P tipi OE'ler sadece 15cm ve 20cm anma ölçüsünde mevcuttur. Bunların sipariş kodlarının A veya P harfi eklenir. Örnek; EG OE 1506 A

# ÖLÇÜLER

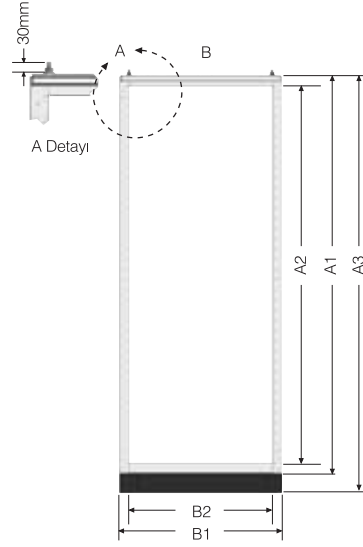

## Örnek Ölçülendirme

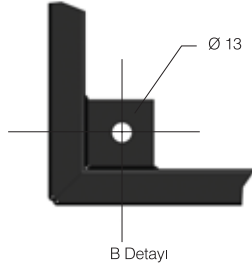
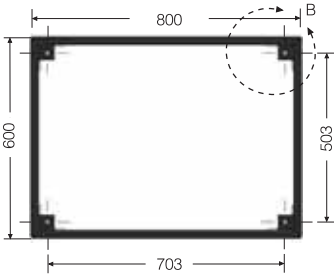
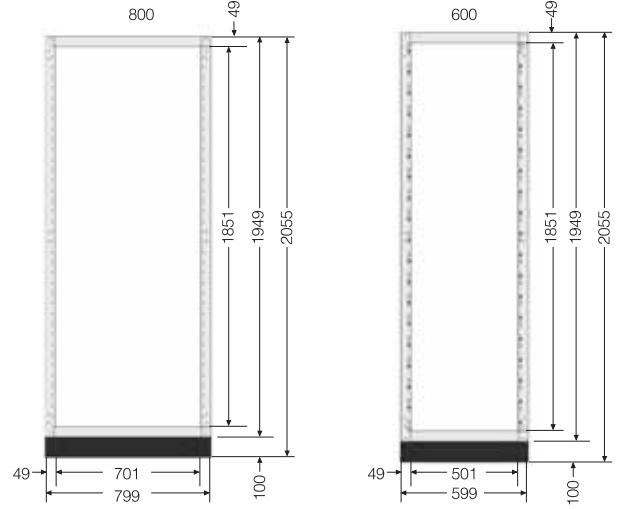

Net Ölçüler	Kabin anma yüksekliği		
	18	20	22
A1	1749mm	1949mm	2149mm
A2	1651mm	1851mm	2051mm
A3	1855mm	2055mm	2255mm

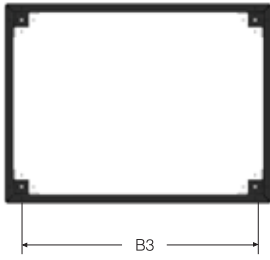

Net Ölçüler	Kabin anma genişliği veya derinliği				
	04	05	06	07	08
B1	399mm	499mm	599mm	699mm	799mm
B2	301mm	401mm	501mm	601mm	701mm
B3	303mm	403mm	503mm	603mm	703mm

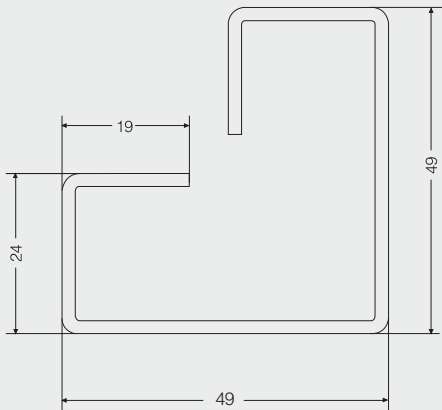

DP Dikey Profil Kesiti

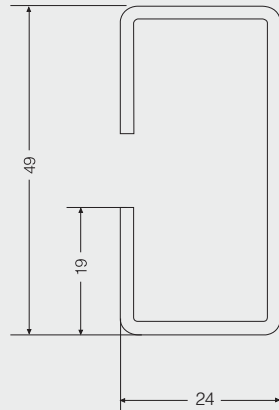

YP Yatay Profil Kesiti

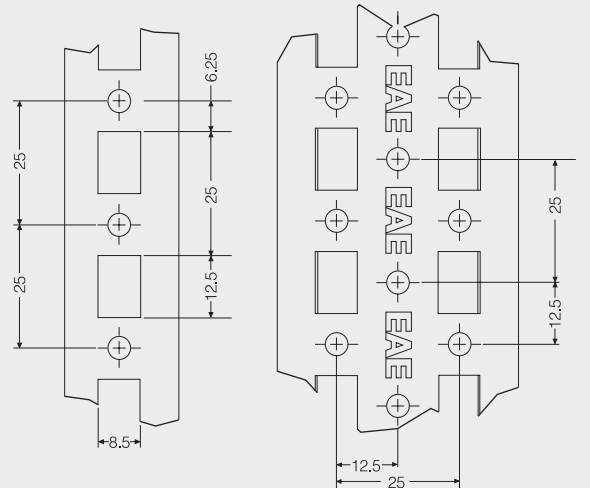

Tüm ölçüler mm'dir



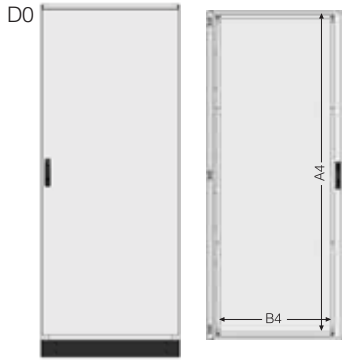

### D0 tipi ön kapı kullanılabılır alan yükseklik ölçüleri (A4)

Ölçü/A4	ED OK 18	ED OK 20	ED OK 22
---------	----------	----------	----------

Net Ölçü 1605mm 1805mm 2005mm

### D0 tipi ön kapı kullanılabılır alan genişlik ölçüleri (B4)

Ölçü/B4	04	05	06	07	08
---------	----	----	----	----	----

Net Ölçü 240mm 340mm 440mm 540mm 640mm

Örnek: ED OK 2008 D0

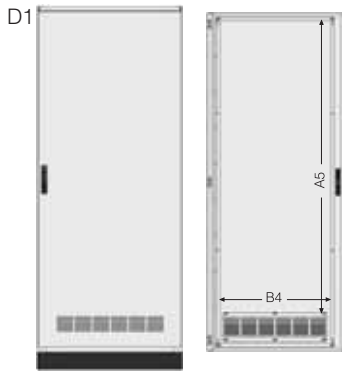
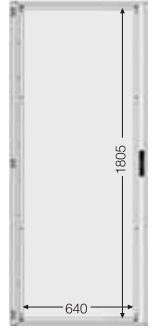

### D1 tipi ön kapı kullanılabılır alan yükseklik ölçüleri (A5)

Ölçü/A5	ED OK 18	ED OK 20	ED OK 22
---------	----------	----------	----------

Net Ölçü 1430mm 1630mm 1830mm

Örnek: ED OK 2008 D1

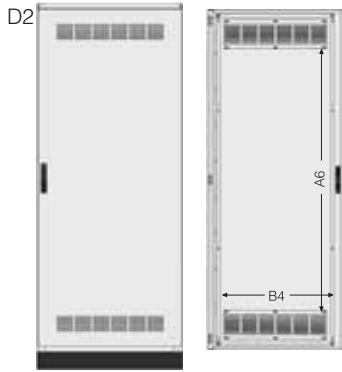

### D2 tipi ön kapı kullanılabılır alan yükseklik ölçüleri (A6)

Ölçü/A6	ED OK 18	ED OK 20	ED OK 22
---------	----------	----------	----------

Net Ölçü 1255mm 1455mm 1655mm

Örnek: ED OK 2008 D2

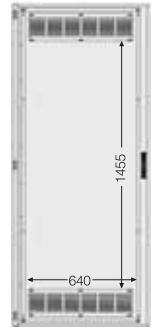

### MP Montaj Plakaları Net Ölçüleri

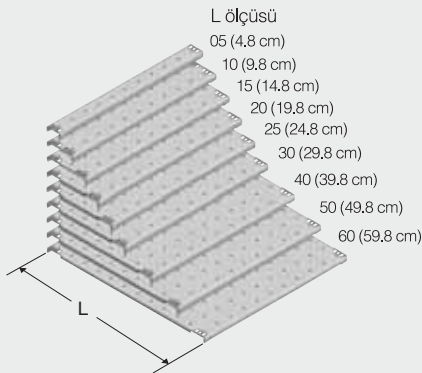

### MK Boy Montaj Plakaları Net Ölçüleri

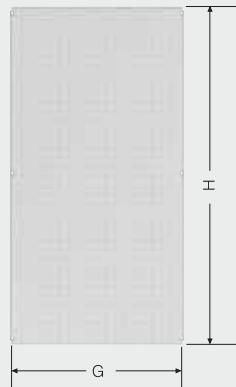

Yükseklik	Net ölçü
18	164.5cm
20	184.5cm
22	204.5cm
Genişlik	Net ölçü
04	34.6cm
05	44.6cm
06	54.6cm
08	74.6cm
10	94.6cm
12	114.6cm

### MO Boy Montaj Plakaları Net Ölçüleri

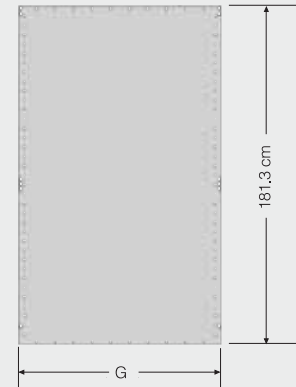

Genişlik	08	10	12
Net Ölçü	70.0cm	90.0cm	110.0cm

# İSKELET KURULUMU



①



②



③



④

Baza ve üst kapak montajı ile birlikte iskelet kurulumu 2 çalışan ile 15 dakika içinde gerçekleştirilebilir.

## AMBALAJLAMA

DİKEY PROFİL SETİ

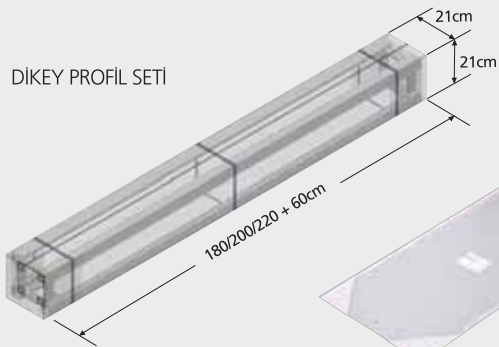

SABİT KAPAK

ÖN KAPI



MODÜL SETİ

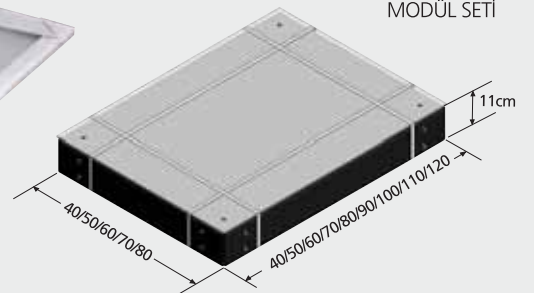

E-KABİN S	Dikili Tip Modüler Kabinler IP 55
E-KABİN D	Dikili Tip Modüler Kabinler IP 41
E-KABİN M	Monoblok Kabinler IP 66
E-KABİN E	İç Tesisat Duvar Tipi Kabinler IP 30
E-KABİN L	İç Tesisat Dikili Tip Kabinler IP 55
E-KABİN H	Harici Tip Kabinler IP 55 - 66
E-KABİN X	Paslanmaz Tip Kabinler IP 55 - 67
E-KABİN K	Kumanda Konsolları IP 55
E-KABİN T	Terminal Kutuları IP 67
E-KABİN B	Bakır Bara Düzenekleri Kısa Devre Tip - Test Belgeli



ELEKTROTEKNİK

[www.eae.com.tr](http://www.eae.com.tr)

İkitelli Organize Sanayi Bölgesi  
Turgut Özal Caddesi No. 112  
İkitelli 34306 İstanbul / Türkiye  
Tel : +90 (212) 549 26 39 (pbx)  
Faks : +90 (212) 549 37 91  
E-posta : [ekabin@eae.com.tr](mailto:ekabin@eae.com.tr)  
Web : [www.ekabin.com](http://www.ekabin.com)